

MU-FLK SERIES

1W UNREGULATED

AvivEnergy^{tech} Ltd.

FEATURES

- SINGLE IN LINE PACKAGE
- UP TO 1W UNREGULATED OUTPUT POWER
- 100% BURN IN
- HIGH EFFICIENCY
- INTERNAL SMD TECHNOLOGY
- LOW COST
- NO HEATSINK REQUIRED
- UL 94V-0 PACKAGE MATERIAL
- CUSTOM SOLUTIONS AVAILABLE
- RoHS COMPLIANT
- 3 YEARS WARRANTY



OUTPUT SPECIFICATIONS

Voltage Set-point Accuracy	+/-2% max
Temperature Coefficient	+/-0.05%/°C
Ripple & Noise(20MHz BW) ¹	100mVp-p max
Line Regulation ²	+/-1.2% max
Load Regulation ³ (other Vout)	+/-8% max
Load Regulation ⁴ (3.3V Vout)	+/-12% max
Minimum Load	10% of Full Load
Short Circuit Protection	Momentary

INPUT SPECIFICATIONS

Input Voltage Range	+/-10% max
Input Filter	Capacitor Typ
Input Reflected Ripple Current	50mA _{p-p} max
Fuse Rated	1A~1.5A (Built-in ,Suffix"F")

GENERAL SPECIFICATIONS

Efficiency	70%-82%
Isolation Voltage ⁵	1500 VDC min (also available with 3,000VDC ,Suffix"K")
Isolation Resistance	⁹ 10 ohms min
Isolation Capacitance	80pF max
Switching Frequency	100KHz Typ
MTBF ⁶	>2,000,000 Hours
Weight	1.3g Typ
Case Material	Non-Conductive Plastic
Case A Size	11.7mm*6.0mm*10.2mm
Case B Size	11.7mm*7.5mm*10.1mm
Conducted Emissions	EN55022 Class A
Radiated Emissions	EN55022 Class B

ENVIRONMENTAL SPECIFICATIONS

Operating Temperature	-40 °C to +85 °C
Case Temperature	+100 °C max
Storage Temperature	-55 °C to +125 °C
Humidity	95% max
Cooling	Free-Air Convection

¹ Measured with 1uF ceramic capacitor connect to the output pins.

² Line Regulation is for a 1.0% change in input Voltage.

³ Load Regulation is for output load current change from 20% to 100%.

⁴ Load Regulation is for output load current change from 20% to 100% when input voltage is 3.3V.

⁵ VDC for 10 seconds,3000VDC for 3 seconds.

⁶ MIL-HDBK-217F @25 °C , Ground Benign.

● **SELECTION GUIDE**
ISOLATION 1500VDC

MODEL NUMBER	INPUT VOLTAGE (VDC)	OUTPUT VOLTAGE (VDC)	OUTPUT CURRENT (mA)	INPUT ⁷ CURRENT(mA)		EFF (%) ⁸	ISOLATION (VDC)	PACKAGE
				FULL LOAD	NO LOAD			
MUS-03.305(F)L	3.3	5	200	406	46	75	1500	B
MUS-0505(F)L	5	5	200	260	31	77	1500	A
MUS-0509(F)L	5	9	110	260	31	77	1500	A
MUS-0512(F)L	5	12	84	256	31	78	1500	A
MUS-0515(F)L	5	15	67	253	31	79	1500	A
MUS-1203.3(F)L	12	3.3	300	112	13	74	1500	A
MUS-1205(F)L	12	5	200	105	13	79	1500	A
MUS-1209(F)L	12	9	110	106	13	78	1500	A
MUS-1212(F)L	12	12	84	102	13	80	1500	A
MUS-1215(F)L	12	15	67	102	13	80	1500	A
MUS-2403.3(F)L	24	3.3	300	57	9	73	1500	B
MUS-2405(F)L	24	5	200	53	9	78	1500	B
MUS-2409(F)L	24	9	110	55	9	76	1500	B
MUS-2412(F)L	24	12	84	54	9	77	1500	B
MUS-2415(F)L	24	15	67	54	10	77	1500	B

Note: Other input to output voltages may be available. Please contact factory.

● **PARTNUMBERS STRUCTURE**

Model Name	Difference
MUS-x1x2(F)L	<p>M=Series Name U=Unregulated S=single output x1=input voltage(03.3 ; 05 ; 12 ; 24) x2=Output voltage(03.3 ; 05 ; 09 ; 12 ; 15) F= Fuse(Optional, if Suffix" F") L= Operating Temperature=-40 °C to +85 °C</p>

⁷ NOMINAL INPUT VOLTAGE.

⁸ NOMINAL INPUT VOLTAGE, FULL LOAD.

● SELECTION GUIDE ISOLATION 3000VDC

MODEL NUMBER	INPUT VOLTAGE (VDC)	OUTPUT VOLTAGE (VDC)	OUTPUT CURRENT (mA)	INPUT ⁹		EFF (%) ¹⁰	ISOLATION (VDC)	PACKAGE
				CURRENT(mA)				
				FULL LOAD	NO LOAD			
MUS-03.303.3(F)LK	3.3	3.3	303	403	43	75	3000	B
MUS-03.305(F)LK	3.3	5	200	404	46	75	3000	B
MUS-0505(F)LK	5	5	200	260	31	77	3000	B
MUS-0509(F)LK	5	9	110	260	31	77	3000	B
MUS-0512(F)LK	5	12	84	256	31	78	3000	B
MUS-0515(F)LK	5	15	67	253	31	79	3000	B
MUS-1203.3(F)LK	12	3.3	300	112	13	74	3000	B
MUS-1205(F)LK	12	5	200	105	13	79	3000	B
MUS-1209(F)LK	12	9	110	106	13	78	3000	B
MUS-1212(F)LK	12	12	84	102	13	80	3000	B
MUS-1215(F)LK	12	15	67	102	13	80	3000	B
MUS-2403.3(F)LK	24	3.3	300	57	9	73	3000	B
MUS-2405(F)LK	24	5	200	53	9	78	3000	B
MUS-2409(F)LK	24	9	110	55	9	76	3000	B
MUS-2412(F)LK	24	12	84	54	9	77	3000	B
MUS-2415(F)LK	24	15	67	54	10	77	3000	B

Note: Other input to output voltages may be available. Please contact factory.

● PARTNUMBERS STRUCTURE

Model Name	Difference
MUS-x1x2(F)L(K)	<p>M=Series Name U=Unregulated S=single output x1=input voltage(03.3 : 05 : 12 : 24) x2=Output voltage(03.3 : 05 : 09 : 12 : 15) F= Fuse(Optional, if Suffix" F") L= Operating Temperature=-40 °C to +85 °C K= Isolation Voltage 3KVDC (Optional, if Suffix" K")</p>

⁹ NOMINAL INPUT VOLTAGE.

¹⁰ NOMINAL INPUT VOLTAGE, FULL LOAD.

- MECHANICAL DIMENSIONS & RECOMMENDED FOOTPRINT DETAILS

PACKAGE A

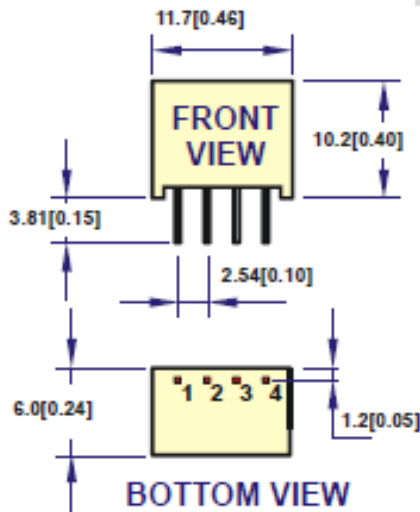

PIN	SINGLE
1	-Vin
2	+Vin
3	-Vout
4	+Vout

NOTE: Pin Size Is Tolerance $0.50\Phi \pm 0.05\text{mm}$
 All Dimensions In mm(Inches)
 Tolerance .X or .XX= $\pm 0.5\text{mm}$

All dimensions are in mm[inches]

PACKAGE B

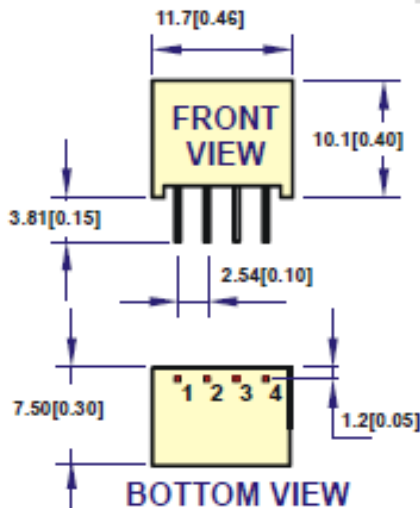

PIN	SINGLE
1	-Vin
2	+Vin
3	-Vout
4	+Vout

NOTE: Pin Size Is Tolerance $0.50\Phi \pm 0.05\text{mm}$
 All Dimensions In mm(Inches)
 Tolerance .X or .XX= $\pm 0.5\text{mm}$

All dimensions are in mm[inches]

PACKAGE A

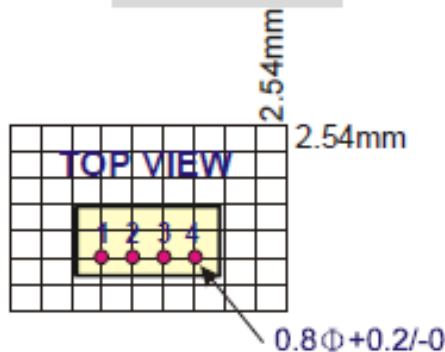

PACKAGE B

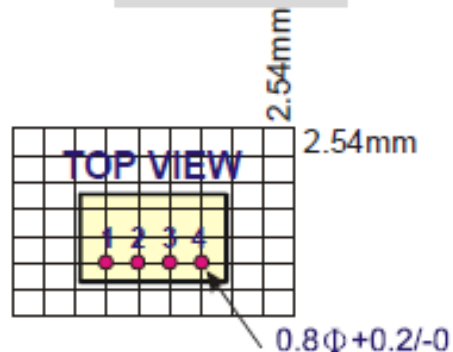

● SIMPLIFIED SCHEMATIC

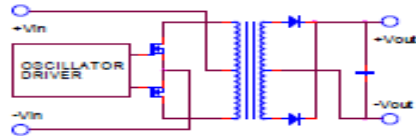

● TYPICAL APPLICATIONS

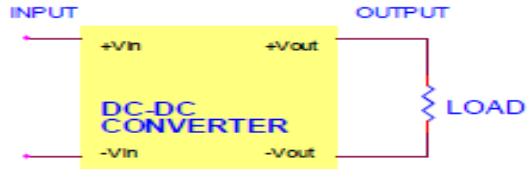

● TYPICAL PERFORMANCE CURVES

Specifications typical at $t_a=25^{\circ}\text{C}$, nominal input voltage, rated output current unless otherwise specified.

VOUT VS LOAD(3.3Vout Models)

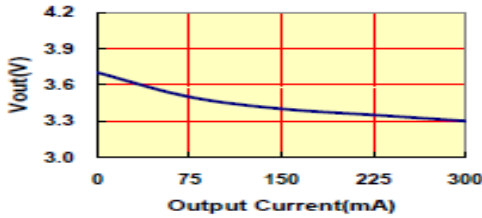

VOUT VS LOAD(5Vout Models)

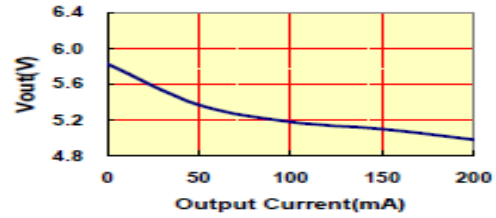

VOUT VS LOAD(9Vout Models)

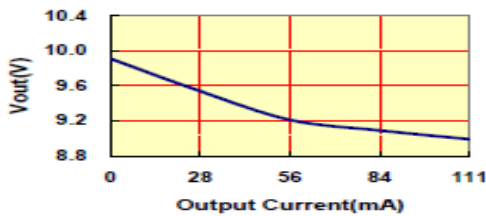

VOUT VS LOAD(12Vout Models)

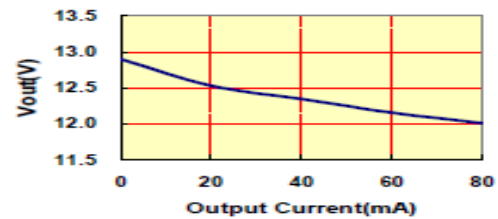

VOUT VS LOAD(15Vout Models)

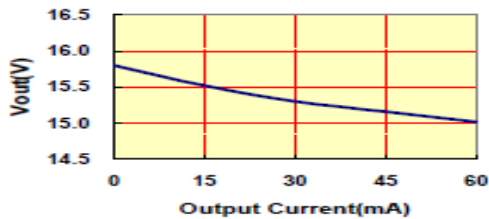

EFFICIENCY VS LOAD

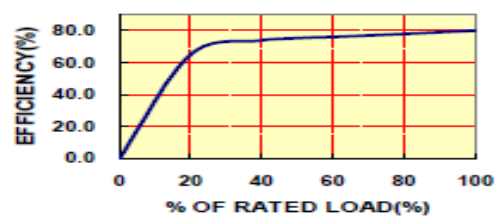

DERATING CURVE

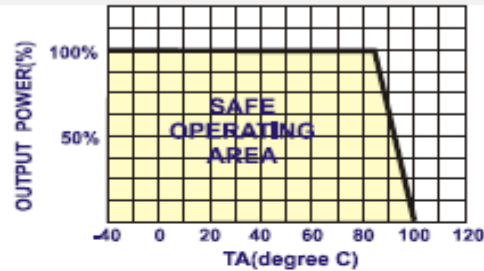

● INPUT FUSE SELECTION GUIDE

3.0-3.6V	4.5-5.5V	10.8-13.2V	21.6-26.4V
INPUT VOLTAGE(VDC)	INPUT VOLTAGE(VDC)	INPUT VOLTAGE(VDC)	INPUT VOLTAGE(VDC)
1000mA Slow-Blow Type	500mA Slow-Blow Type	250mA Slow-Blow Type	150mA Slow-Blow Type

The diagram shows a yellow box labeled 'DC-DC CONVERTER'. The input terminals are labeled '+Vin' and '-Vin'. A fuse is connected in series with the +Vin input line. The output terminals are labeled '+Vout' and '-Vout'.

Note: Certain applications may require the installation of external fuse in front of the input.